

INTERCONNECTION MODULES

SAFEGATE M SG BOX

GENERAL

The SAFEGATE M SG BOX modules are accessory devices designed to make the wiring of the SAFEGATE and SAFEGATE TRX barriers fast and safe, as well as provide the main controls necessary for their operation close to the protected gate.

In addition to the safety relays with guided contacts piloted and monitored by the light curtain, terminal blocks for connecting the cables, jumpers and dip-switches for the configuration of the barrier itself.

DESCRIPTION

M SG BOX is characterized by:

- Luminous push-button for restart and output status indication.
- Key selector for Override function.
- Connectors for wiring the box to the barrier (M12-12-pole male for RX; M12-5-pole female for TX).
- Fairlead for the connections toward the machine of:
 - power supply;
 - connection with the output contacts of the internal safety relays and relative EDM;
 - Muting function enabling signals coming from outside;
 - output signals which indicate the status of the safety light curtain.

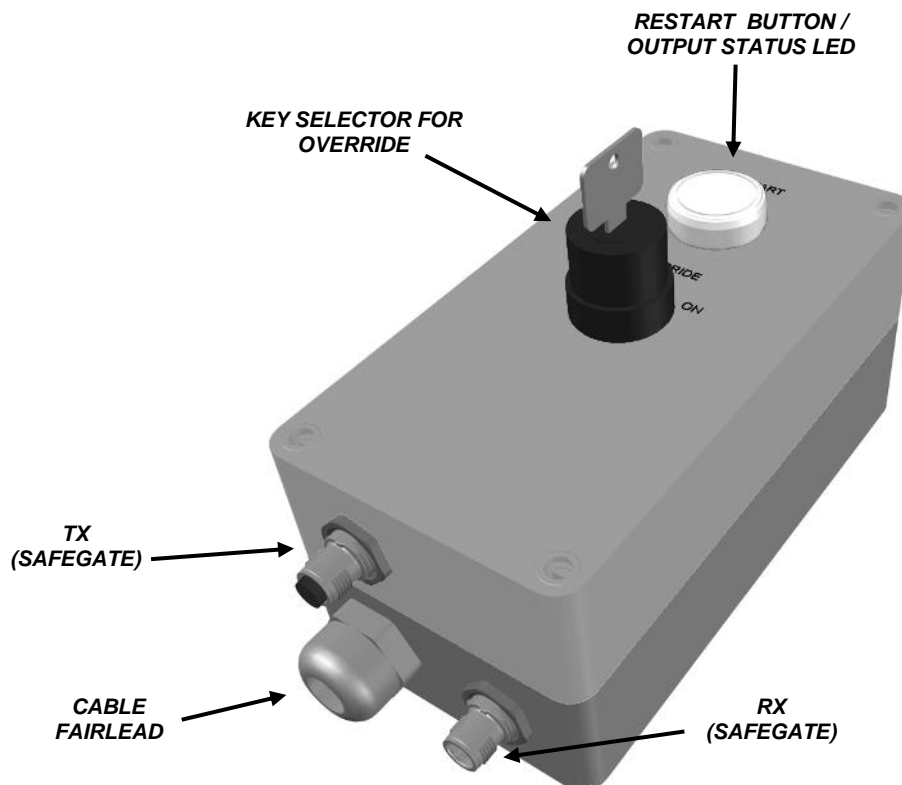

Figure 4 - M SG BOX – Connections and signals

CONFIGURATION

The configuration of the operating modes is described below.

This configuration is performed following the descriptions of the tables below, by setting the various jumper, connectors and dip-switches located on the main board.

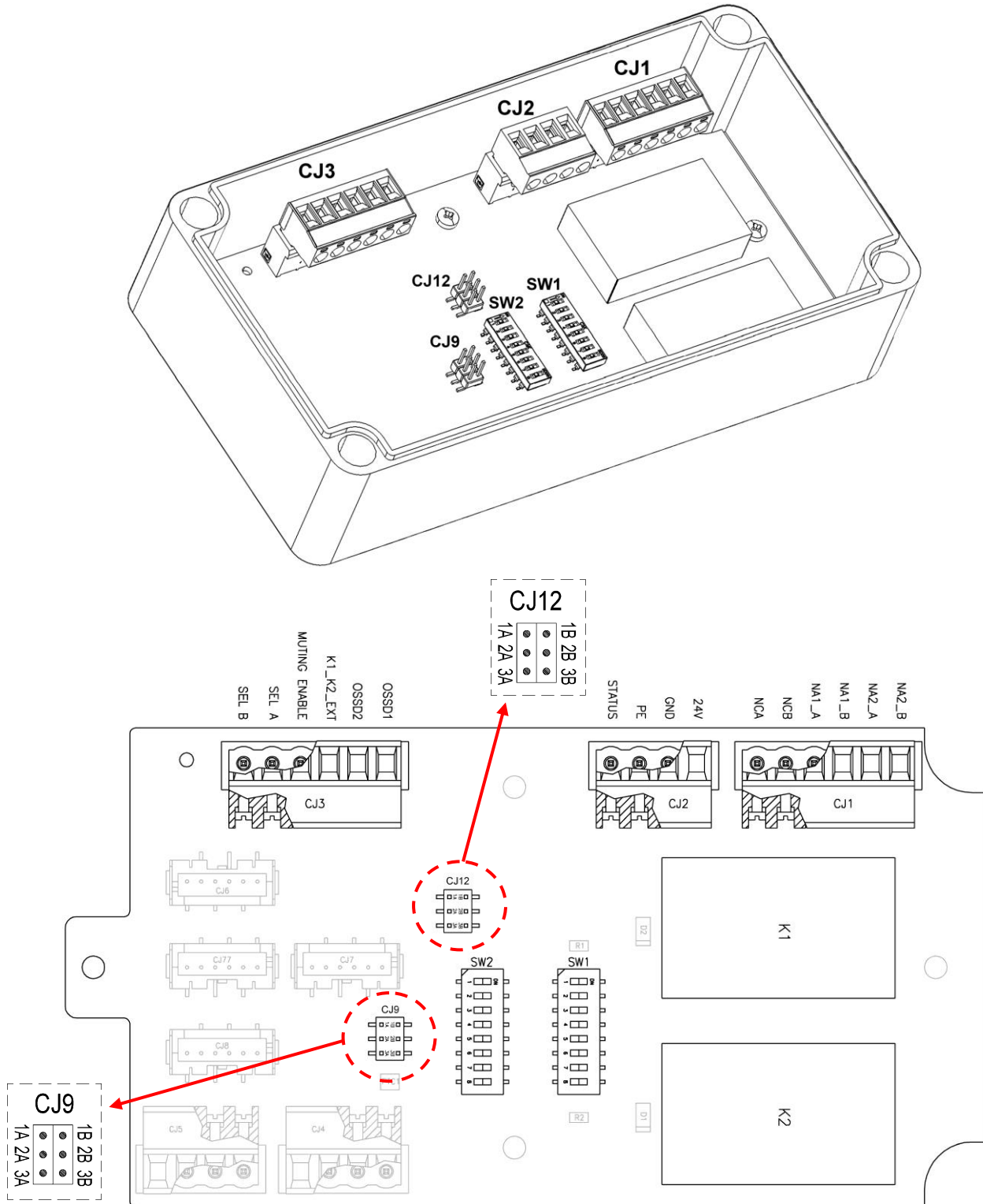
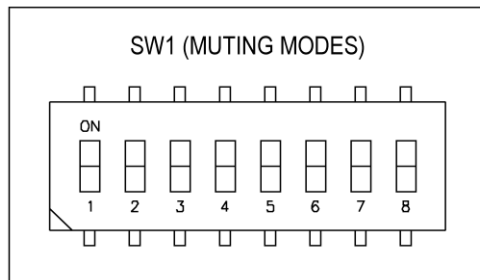

Figure 5 – Main board

SELECTION OF MUTING MODE AND TIMEOUT (DIP-SWITCH SW1)



Manual Mode

Sequential Muting (4 parallel sensors)	on	1 2 3 4 5 6 7 8	Sequential timeout = 30 s
	off		
	on	1 2 3 4 5 6 7 8	Sequential timeout = ∞
	off		
Muting "T" MODE (2 crossed sensors)	on	1 2 3 4 5 6 7 8	Concurrent timeout = 30 s
	off		
	on	1 2 3 4 5 6 7 8	Concurrent timeout = 9 hours
	off		
Muting "L" MODE (2 parallel or crossed sensors)	on	1 2 3 4 5 6 7 8	Concurrent timeout = 30 s
	off		
	on	1 2 3 4 5 6 7 8	Concurrent timeout = 9 hours
	off		
Muting Concurrent (4 crossed sensors)	on	1 2 3 4 5 6 7 8	Concurrent timeout = 30 s
	off		
	on	1 2 3 4 5 6 7 8	Concurrent timeout = 9 hours
	off		
SMP/SMPO Models Programming required	on	1 2 3 4 5 6 7 8	
	off		

OTHER CONFIGURATIONS NOT ALLOWED

Automatic Mode

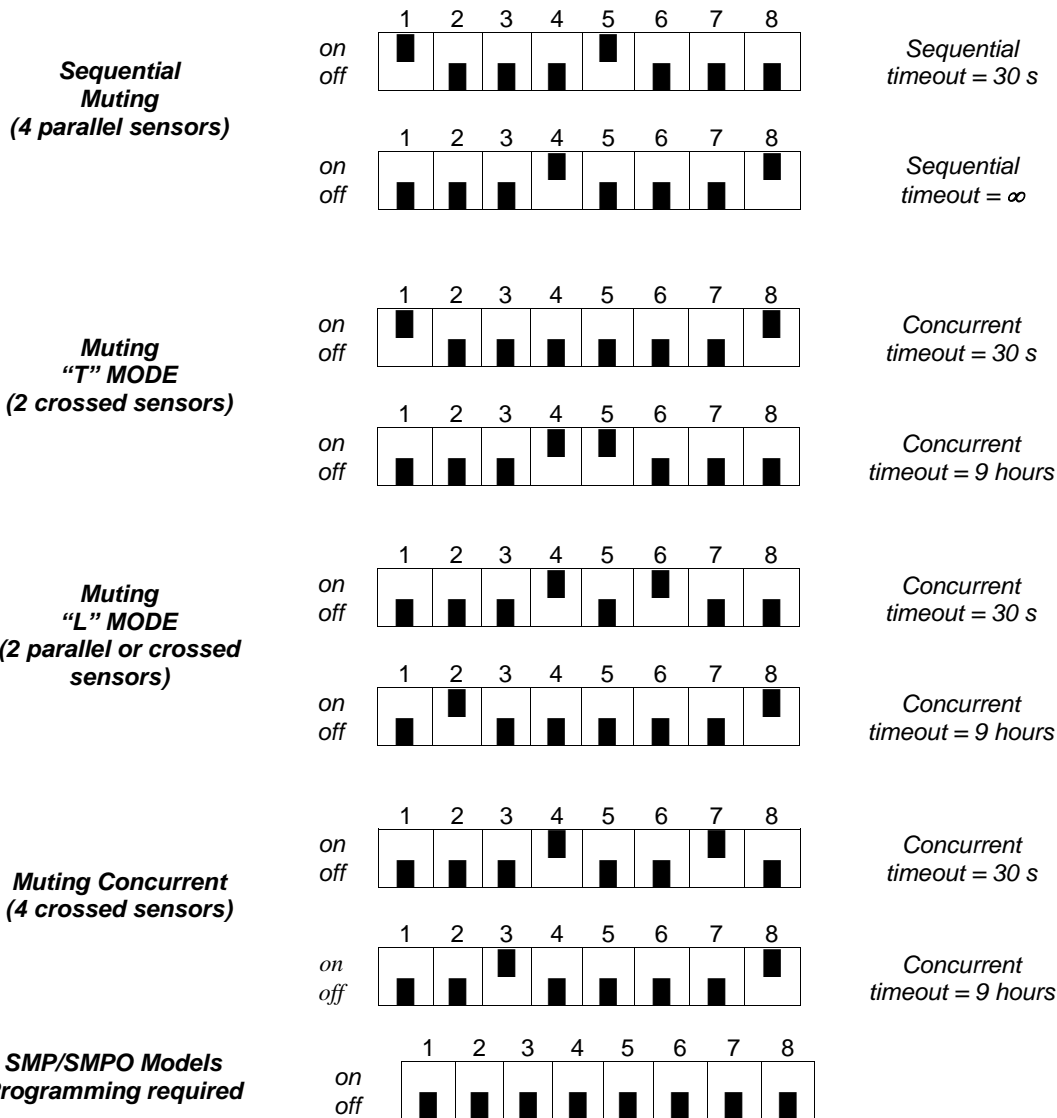

⚠ If a time out limit of 9 hours is a too short time for a particular machine cycle, the configuration without time monitoring ($t=\infty$) can be selected. In this case alternative solutions or additional measures shall be implemented to detected the condition of a muting function permanently active caused by accumulation of faults or by the muting sensors activated all the time. For example for the application of guarding the openings of a conveyor system (palletizers) by monitoring appropriate signals generated by the transport system to determinate if and when a pallet is in the detection zone.

⚠ Perform a specific risk analysis of the application if the timeout $t = \infty$ is selected.

OTHER CONFIGURATIONS NOT ALLOWED

EDM, RANGE, MUTING ENABLE SELECTION (DIP-SWITCH SW2) (VIA HARDWARE)

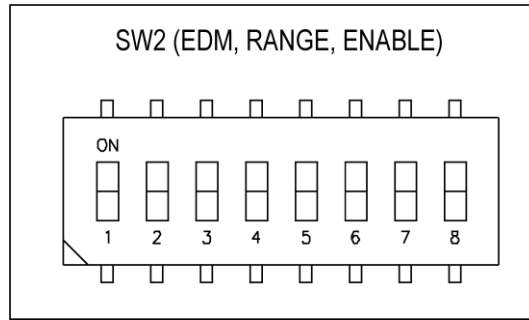

Muting Enable Configuration (Dip-Switch SW2)



Feedback (EDM) enabled (Dip-Switch SW2)

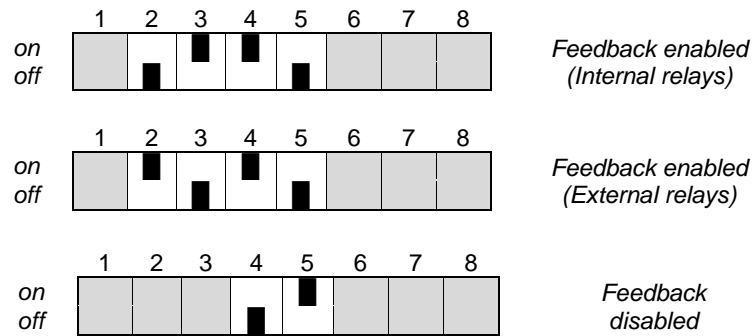

Range Selection (All models – TRX excluded)

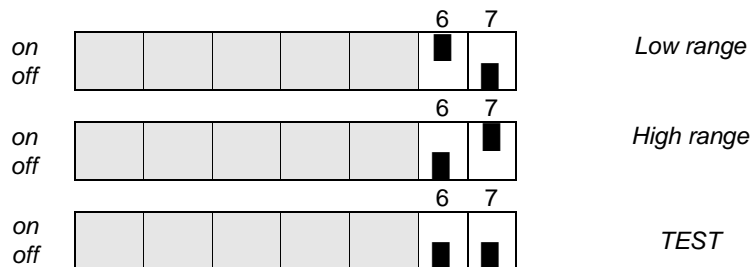

OTHER CONFIGURATIONS NOT ALLOWED

EDM, RANGE, MUTING ENABLE SELECTION (DIP-SWITCH SW2) (VIA SOFTWARE)

➔ All settings of the Dip-Switch SW2 and the Jumper CJ9 must respect the configuration of the Safegate Software.

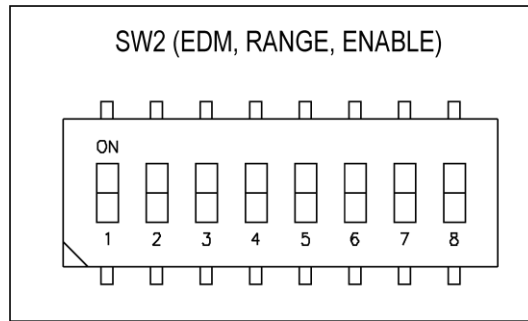

Muting Enable Configuration (Dip-Switch SW2)

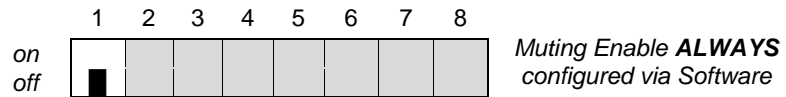

Feedback (EDM) enabled (Dip-Switch SW2)

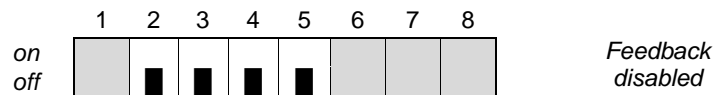
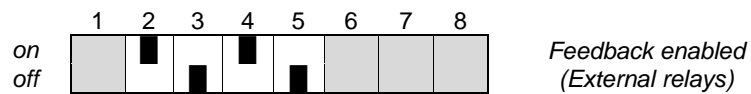
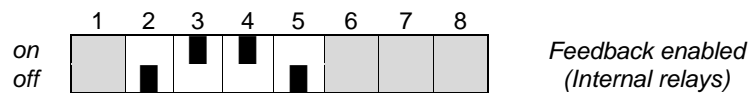

Range Selection (All models – TRX excluded)

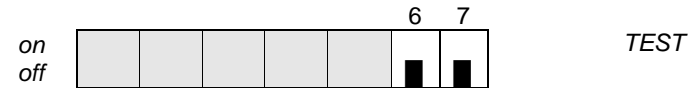
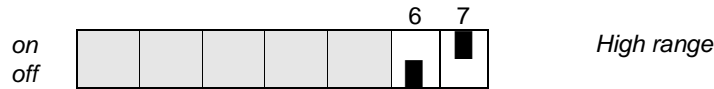
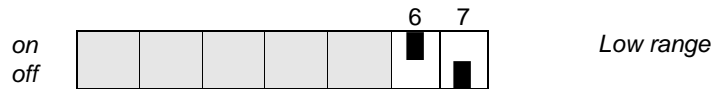

OTHER CONFIGURATIONS NOT ALLOWED

VERRIDE SELECTION (CJ9)

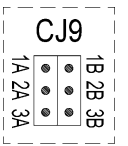
JUMPER	PIN	DESCRIPTION	SELECTION PRESET
	1A ↔ 2A 1B ↔ 2B	Override 1 (Spring Return Key)	Override 1 (Spring Return Key)
	2A ↔ 3A 2B ↔ 3B	Override 2 (Push-button)	

SELECTION STATIC OUTPUTS / RELAYS (CJ12)

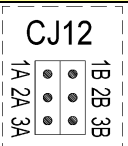
JUMPER	PIN	DESCRIPTION	SELECTION PRESET
	1A ↔ 2A 1B ↔ 2B	Static outputs	Internal Relays
	2A ↔ 3A 2B ↔ 3B	Internal Relays	

INSTALLATION AND ELECTRIC CONNECTIONS

- The M SG BOX modules can be fixed to the wall, using the proper plastic brackets inserted in the holes placed on the box rear side corners. These brackets can easily rotate to reach 90°.
- The light curtain must be connected to the respective connectors M12 (Fig.1) using the dedicated cables.
- The cables coming out from the cable gland (PG11) must be connected - depending on its utilization - to the connectors CJ1, CJ2 and CJ3. Terminal tightening torque: 4,4lb-in (0,5 Nm) is mandatory.
- Use 60/75°C copper (Cu) conductor only. Wire size range: AWG 12÷30, (solid/stranded) (UL).
- The working temperature is: -25°C ÷ 55°C.

Terminal board CJ1		
CLAMP	NAME	DESCRIPTION
1	NA2_B	Ends of the contact normally open n. 2
2	NA2_A	
3	NA1_B	Ends of the contact normally open n. 1
4	NA1_A	
5	NCB	Ends of contacts normally closed, in parallel
6	NCA	

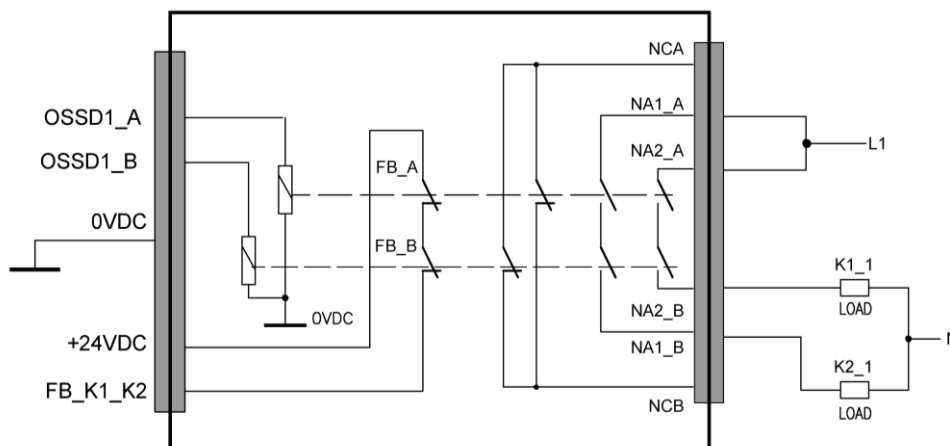

Figure 6 – M SG BOX connection sample

Terminal board CJ2		
CLAMP	NAME	DESCRIPTION
1	+24Vdc	24 ± 20%
2	0V	0 Vdc
3	PE	Protective Earth
4	STATUS	(Ref. SAFEGATE Technical Manual)

Terminal board CJ3		
CLAMP	NAME	DESCRIPTION
1	OSSD1	Output – Barrier OSSD
2	OSSD2	Output – Barrier OSSD
3	K1_K2	Feedback external relays K1/K2 input
4	MUTING_ENABLE	Muting Enable Input
5	SEL_A	Refer to the manual of the connected barrier
6	SEL_B	Refer to the manual of the connected barrier

SIGNALS

SIGNAL	CONDITION	MEANING
OUTPUT STATUS (White)	ON	Outputs active
	OFF (Low intensity blinking)	Light curtain occupied: outputs disabled

SAFETY RELAYS TECHNICAL DATA

The M SG BOX module uses two safety relays with guided contacts for the output circuit. These relays are specified by the manufacturer for voltages and currents greater than those indicated in the technical data; nevertheless to guarantee correct insulation and avoid damage or premature aging, protect each output line with a **3.15 A delayed fuse** and verify that the features of the load conform to the indications on the following table.

TECHNICAL DATA	
Number of contacts	2N.A. - 1N.C.*
Relay category (according to EN60947-5-1)	AC15 / DC13
Max commutable voltage	250Vac, 24Vdc
Min commutable voltage	10Vac/10Vdc
Max commutable current	2A
Min commutable current	10mA@24Vdc
Number of commutations (life)	≥ 50 x 10 ³ (el) / ≥ 40 x 10 ⁶ (mech)

* 1N.C. = DO NOT USE AS A SAFETY CONTACT

MECHANICAL DIMENSIONS

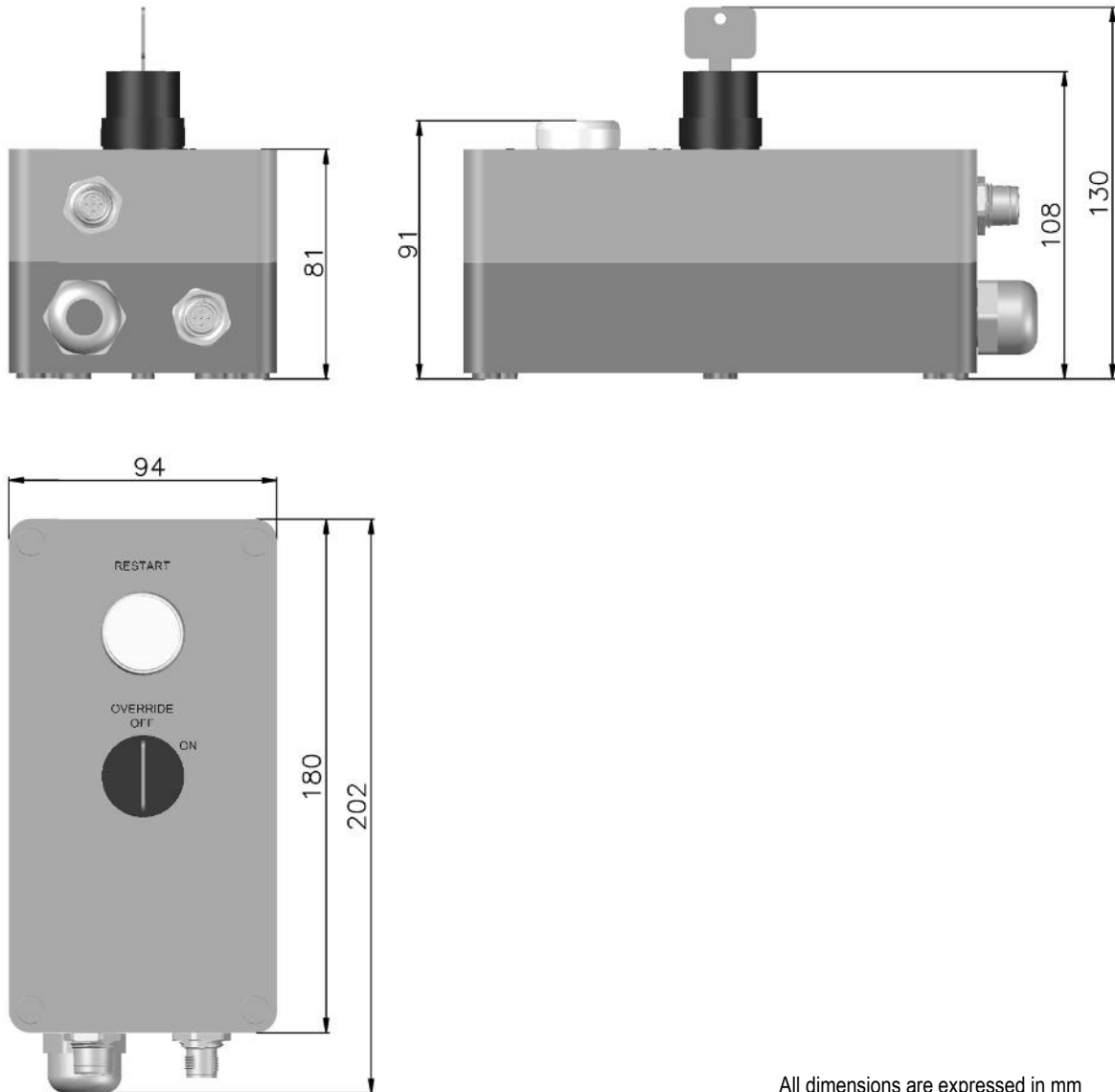

All dimensions are expressed in mm

INDICATIONS AND INFORMATION FOR ENVIRONMENTAL PROTECTION

Dispose of the product in an eco-compatible manner and in accordance with national legislation.

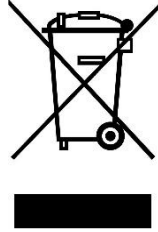

For Countries in the European Union:

Pursuant to the Directive no. 2012/19/EU on waste electrical and electronic equipment (WEEE)

The crossed out wheellie-bin symbol on the equipment or its packaging means that when the product reaches the end of its useful life it must be collected separately from other waste.

Proper separate collection of the discarded equipment for later environment-friendly recycling, processing and disposal, helps to avoid any negative impact on the environment and health and encourages re-use and recycling of the materials the equipment is made of.

In each individual Member State of the European Union this product is required to be disposed of in accordance with Directive **2012/19/EU** as implemented in the Member State where the product is disposed of.

For further information please contact ReeR or your local dealer.

Precise, complete compliance with all standards, instructions and warnings in this handbook is essential for the correct operation of the device.

ReeR S.p.A. therefore declines any responsibility for all and anything resulting from failure to comply with all or some of the aforesaid instructions.

Characteristics are subject to change without prior notice. No part of this document may be reproduced unless authorised by ReeR.



Via Carcano, 32
10153 Torino, Italy
T +39 011 248 2215
F +39 011 859 867
www.reersafety.com
info@reer.it

All REER Safegate manuals and configuration software are available at
www.reersafety.com/download/safegate

